

2835 96+96D Free Cut Dual-color Bare Flexible LED Strip

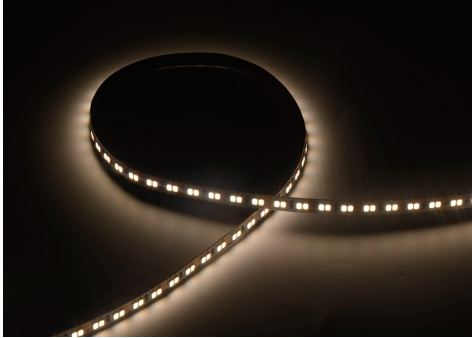

- Product new ID design, special LED customization
- Uniform light emission, easy installation, reliable quality
- ERP spectral classification, single BIN shipment, high cost-effectiveness
- Single-end power supply 5M
- Dual-color temperature lighting, cuttable at any position, suitable for various installation lengths.
- Waterproof grade IP20
- 5 years warranty

Technologies

- ON/OFF

Application

- This product is suitable for home decoration: engineering projects, buildings, hotels, shopping malls, indirect lighting, dark slot lighting, decorative lighting and other purposes.

Color Options



Dimensions

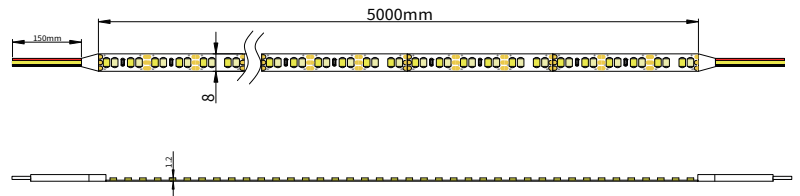

Beam Angle



Product Specifications

P/N	LED	CCT K	CRI	LEDS/m	LUMENS (lm/m)	VIN (V)	Current (mA/M)	Power (W/M)	Cut Length (MM)	Max Run (M)
RL-FV24081922835X-XX	2835	2700 + 6500	80/90	96+96	1000 1200	24	417	10	Free	5

Other Specifications

Protection grade	IP20
Working temperature (°C)	-25~+60
Standard length (°C)	-25~+70
Maximum cascade length(m)	5
Maximum cascade length (m)	5
weight	/

Remark

- The test environment temperature is 25±2°C;
- The above data are typical values, the actual parameters of the product may be different from the typical data; the data is subject to change without notice;
- The above "/" means that this parameter is not required for the time being.

Applied Standards



Installation

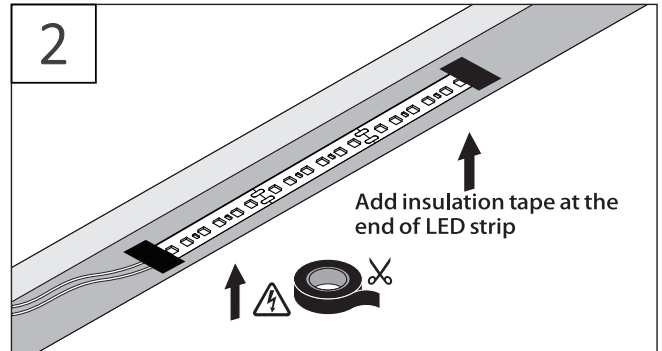
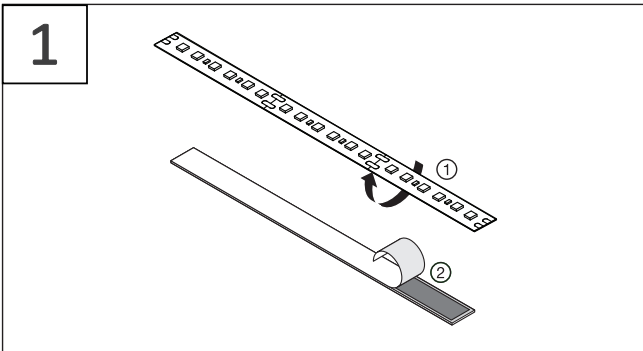

Do's and Don'ts

Minimum Bending Radius

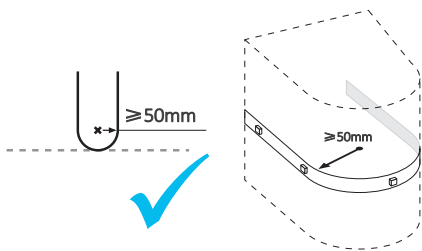

Do Not Twist

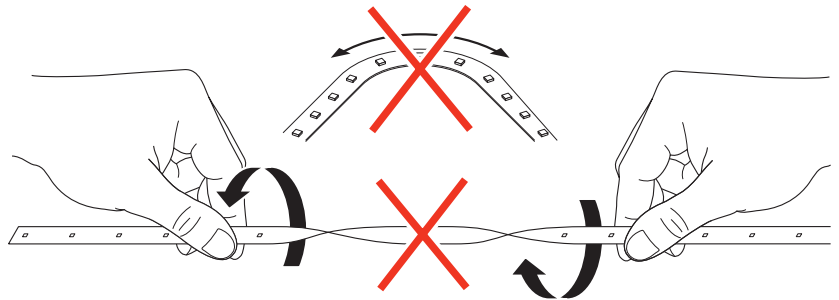

Schematic diagram of electrical connection



Package

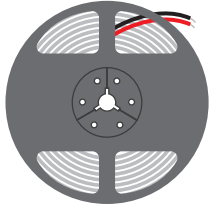

Reel

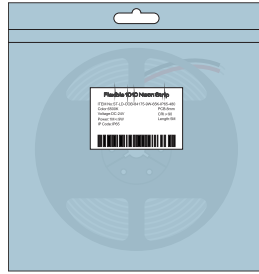

Electrostatic bag

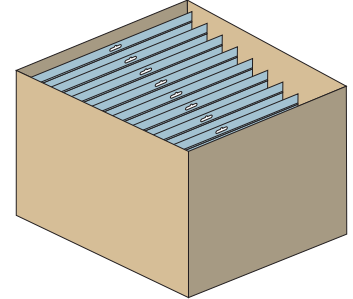

Carton



Packing completed

Quantity per roll (m)	Quantity per case (m)	Total weight (Kg)	Outer box dimensions (mm)		
			Length	Width	Height
5	200	20	550	550	240

Note :The above-mentioned packaging quantity and weight are only for the packaging method shown in the figure. There will be differences in the number and weight of packaging for other packaging methods, and the actual product shall prevail.

Common product faults and their troubleshooting methods

Fault Phenomena	Possible Causes	Troubleshooting Methods
All lights off	1.Mains power failure	Power on
	2.Open circuit or short circuit at switching power supply output triggering auto-protection	Troubleshoot and restore power
	3.Reverse polarity at LED strip power input	Check wire connection status to ensure correct polarity
Partial lights off	1.Partial switching power supply failure	Inspect power supply system and resolve faults
	2.Wiring error in partial LED strip circuits	
	3.Reverse polarity in partial LED strips	Correct wiring
LED uneven brightness or insufficient brightness	1.Power supply overload	Replace with higher-power supply according to load
	2.Excessive line loss in switching power circuits or significant line loss discrepancies	Maintain LED strip operating voltage within $\pm 5\%$ of rated voltage 1.Shorten power cable length between power supply and LED strip or use larger gauge wires; 2.Ensure number of LED strips per circuit \leq max allowed cascading quantity and keep cascading quantities similar per circuit).
	3.Excessive serial connection of LED strips	Adjust LED strip quantity per power branch to meet max allowed cascading requirements per circuit
LED flickering	1.Poor contact at connection points	Identify and resolve poor contact points
	2.Switching power supply malfunction	Replace switching power supply



Notice

- If the external flexible cable of this product is damaged, the cable must be replaced by the manufacturer or similarly qualified personnel to prevent hazards.
- For specific installation arrangements and precautions, refer to the product user manual.
- Data in this specification is based on standard products. Actual delivered products may vary, subject to physical measurements.
- All product diagrams in this specification are schematic diagrams. Actual delivered products may differ, subject to physical objects.
- Technical modifications may be implemented without prior notice.
- Shenzhen Meishang Lighting Co., Ltd. reserves the final interpretation rights of this manual.



Specialized
LED Strip Manufacturer

Shenzhen
Relight Technology Co.,Ltd

6th Floor, Building A, Guancheng IndustrialPark,Gongming Town,
Guangming District, Shenzhen, China

Tel: 86 0755 3369 1713
Web: www.relight-tech.com
E-mail: Sales@relight-tech.com